

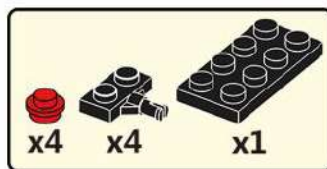

Сборка модели 1

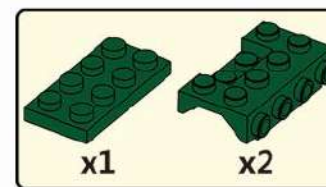

A1

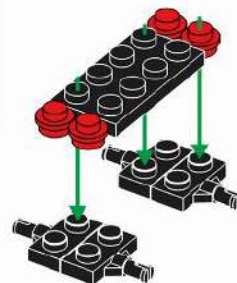

A2

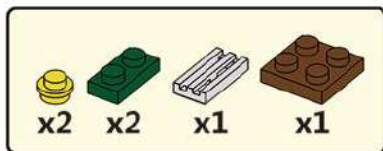
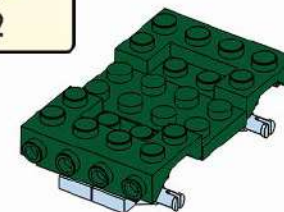

A3

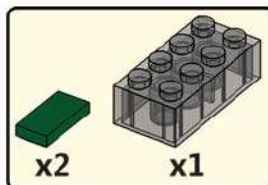
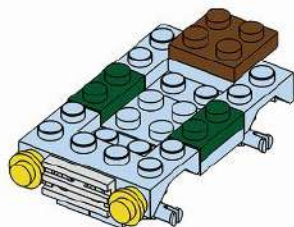

A4

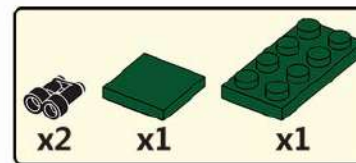
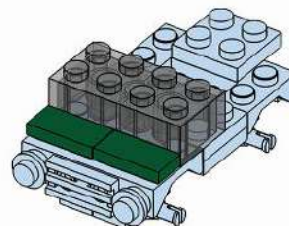

A5

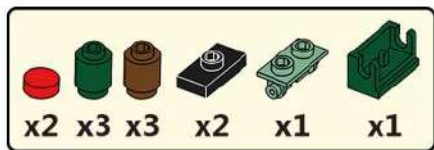
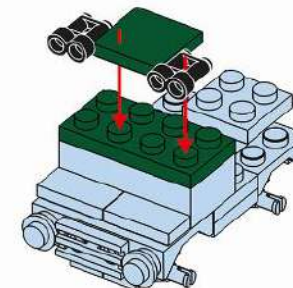

A6

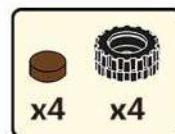
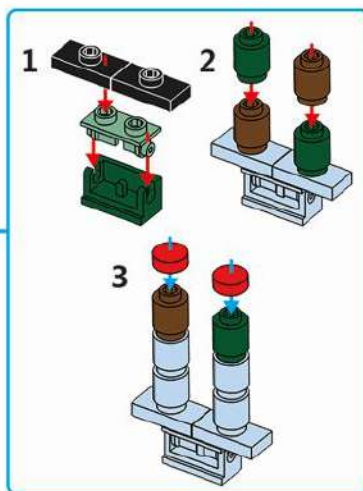
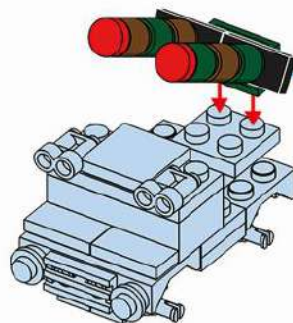

A7

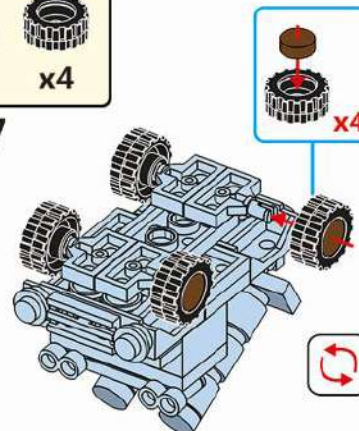

A8

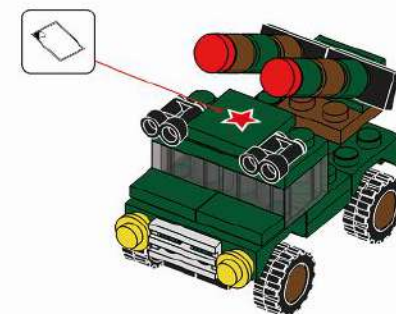

Сборка модели 2

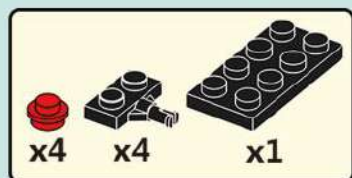

B1

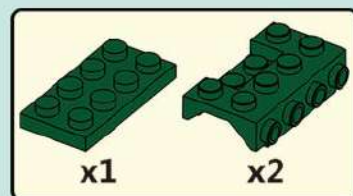
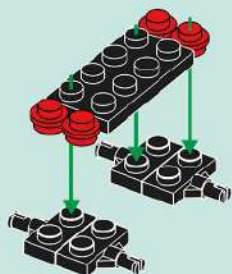

B2

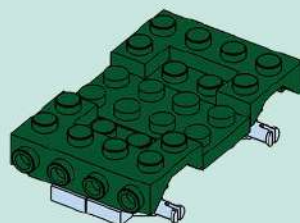

B3

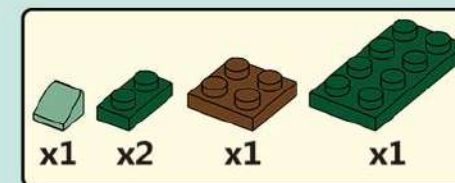
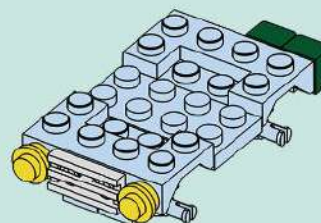

B4

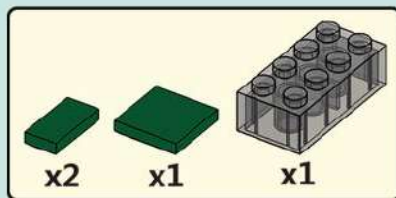
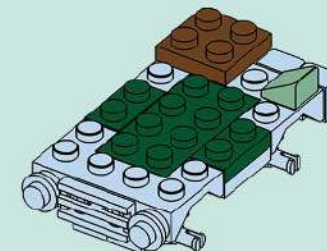

B5

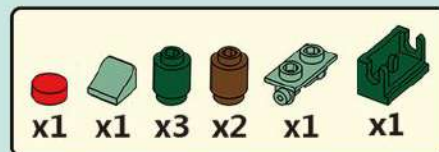
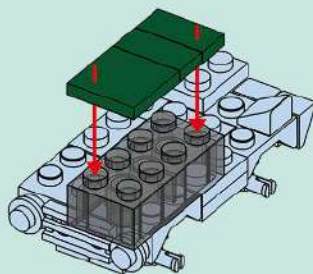

B6

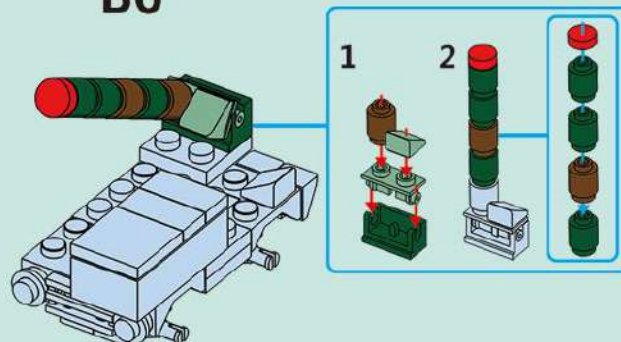

B7

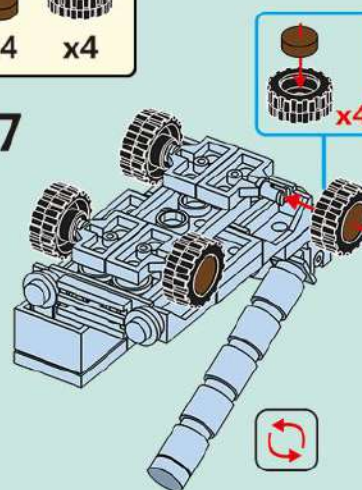

B8

