



1

X1 X1 X1 X1 X1 X1 X1 X1 X1 X2

2

X2 X4 X4 X2 X4

X4

X2

3

X1 X1

4

X1 X1 X1 X2 X1 X2

5

X2 X1

3 + 4

6

X2 X1

7

X2

8

X1 X1 X1 X1

9

X1 X2 X1 X2 X2

X2

10

X1 X1 X2

11

X2 X1

12

X2 X2 X2 X1 X2 X1 X4

13

14

7
+
11
+
13

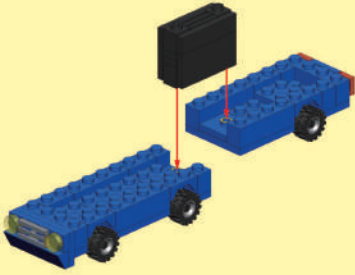

15

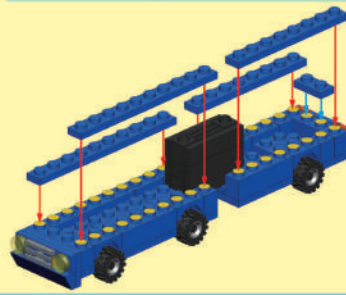
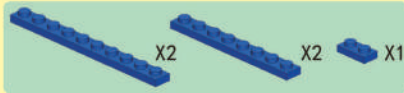

16

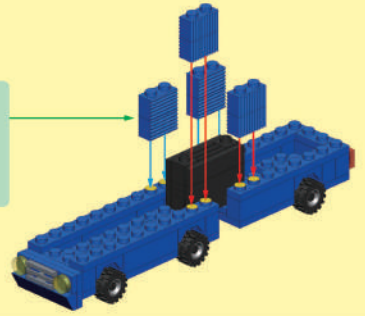
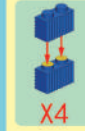

17

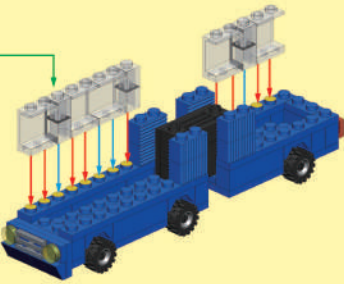

18

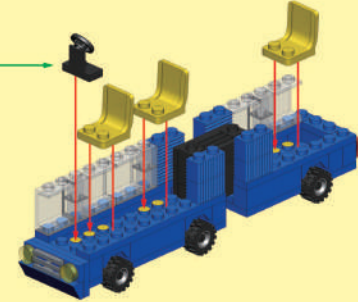

19

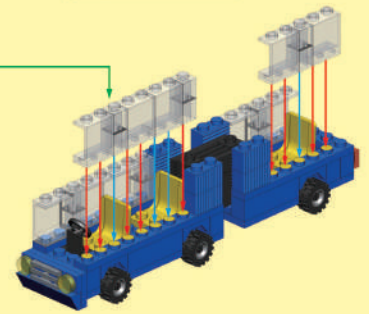

20

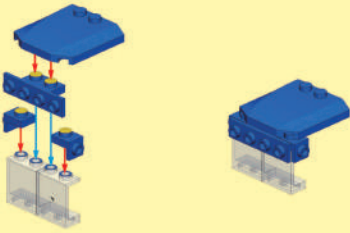

21



19
+
20

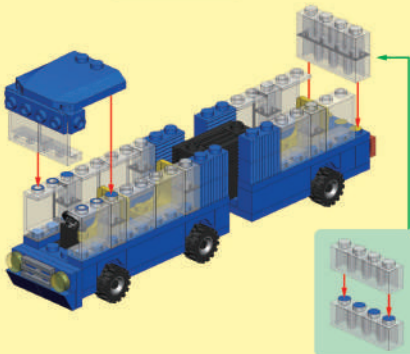

22

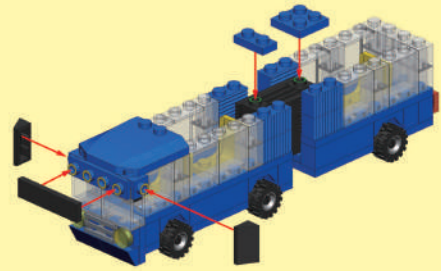

23

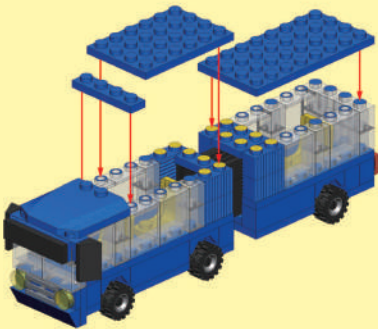
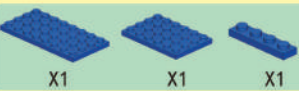

24

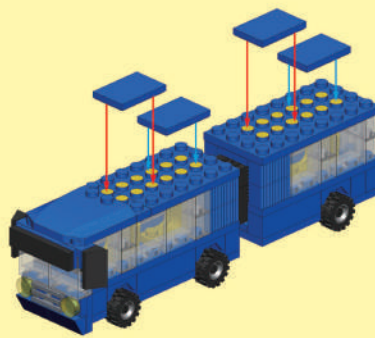

25

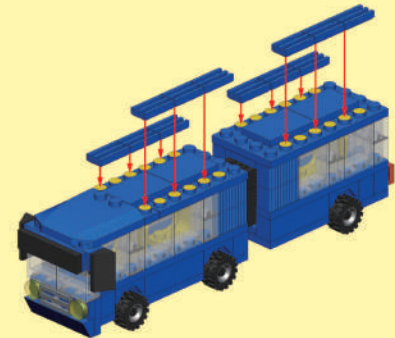

26

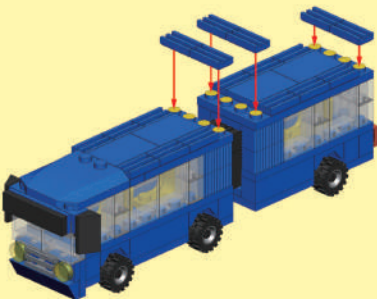

27

1
+
26

