

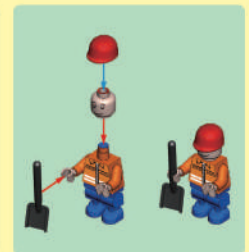

1

- X2
- X1
- X2
- X2
- X2
- X2
- X2
- X2
- X2
- X4

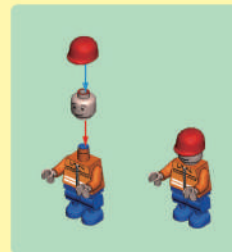
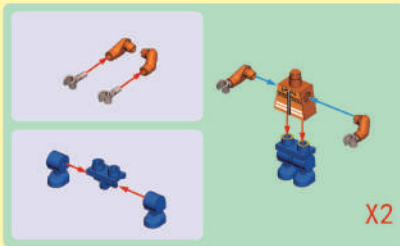

2



3

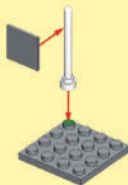
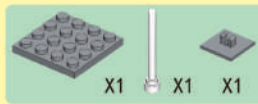

4

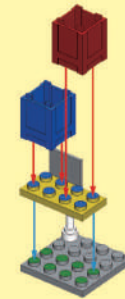

5

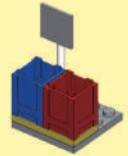

6

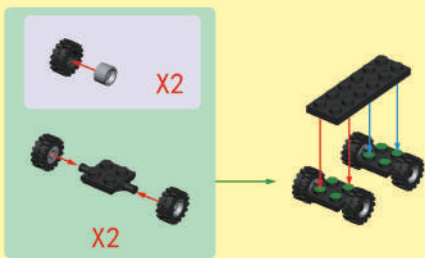

7

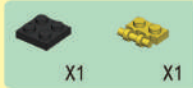

8

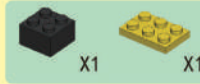

9

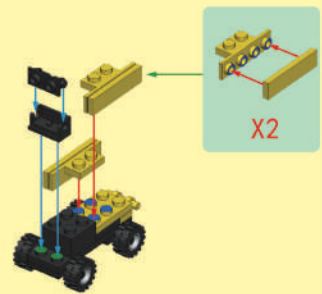

10

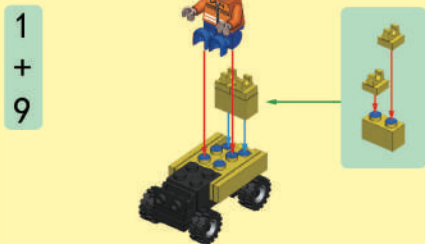

11



12

10 + 11



13

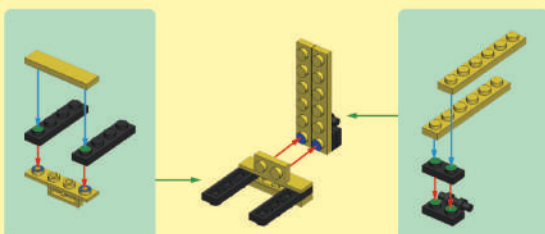

14

12 + 13

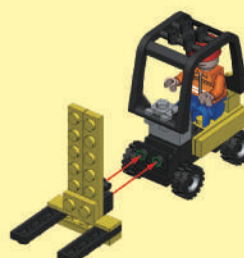

15



16

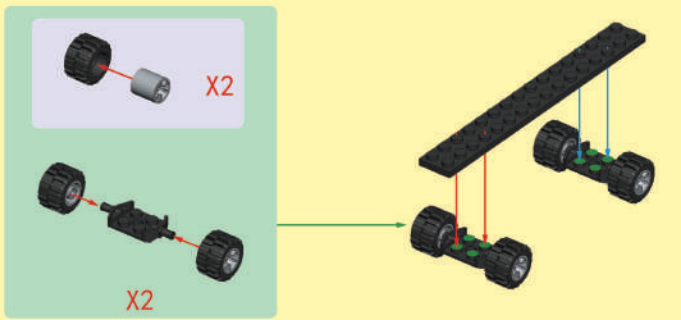
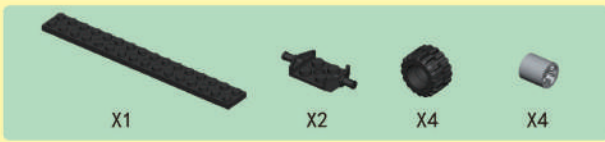

17

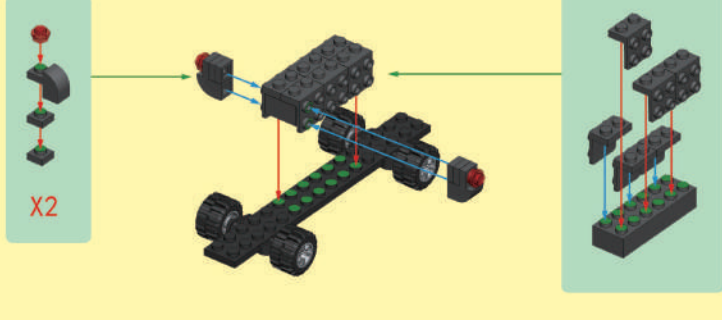
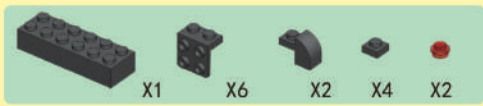

18

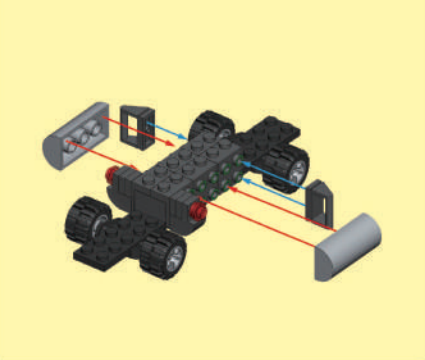
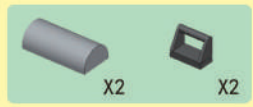

19

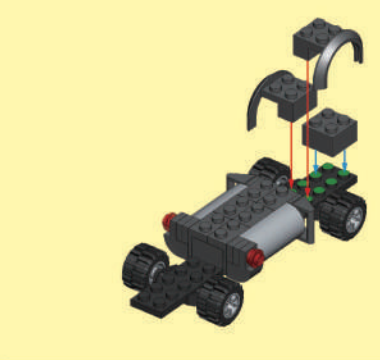
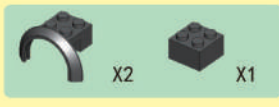

20

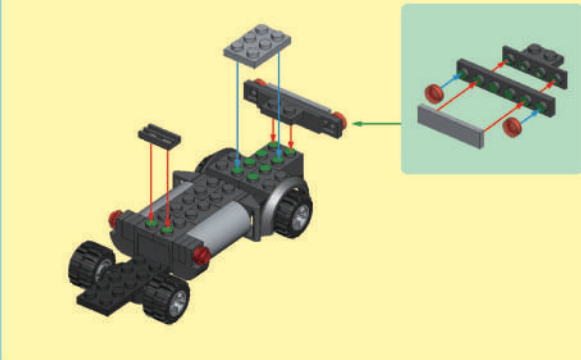
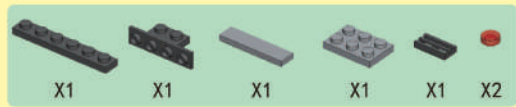

21

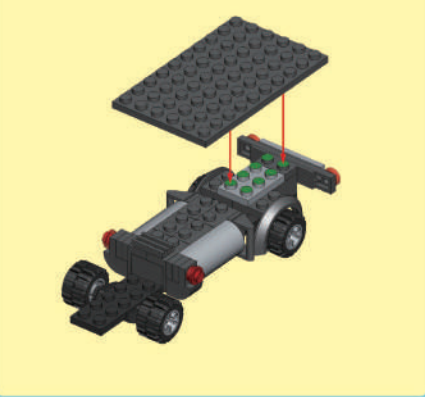

22

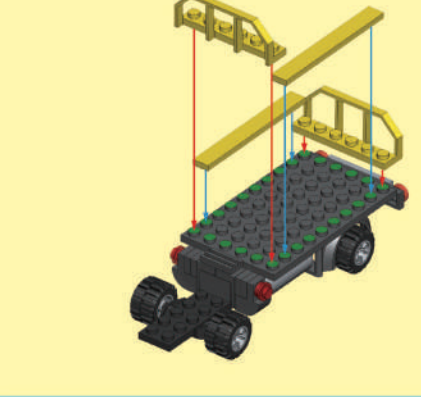

23

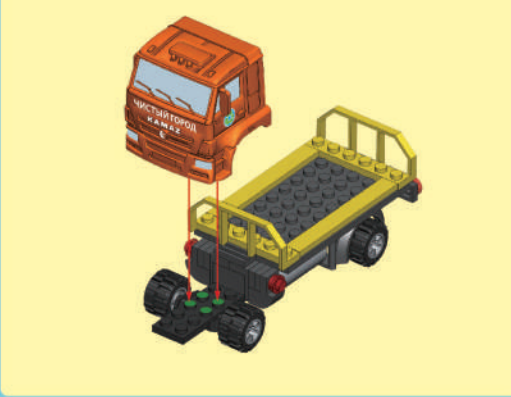

24

1 + 2 + 5 + 15 + 23

