



4+

3252

- x1
- x1
- x2
- x30
- x2
- x2
- x2
- x2
- x2
- x2
- x1
- x1
- x1
- x2
- x2
- x4
- x2
- x2
- x2
- x2
- x2
- x1
- x1
- x1
- x4
- x1
- x1
- x1
- x2
- x2
- x2
- x2
- x2
- x1
- x1
- x4
- x2
- x2
- x2
- x2
- x1

1

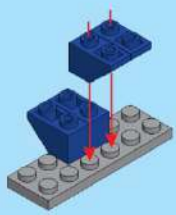

2

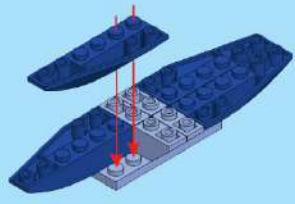

3

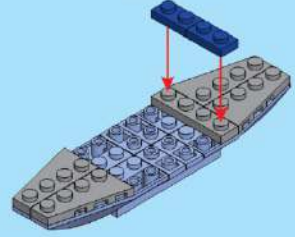

4

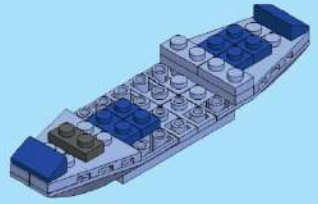

5

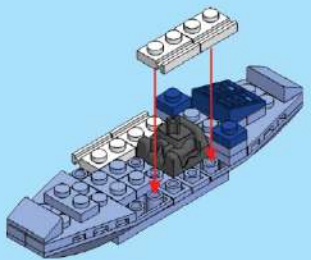

6

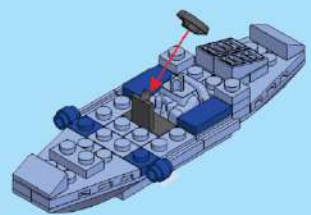

7

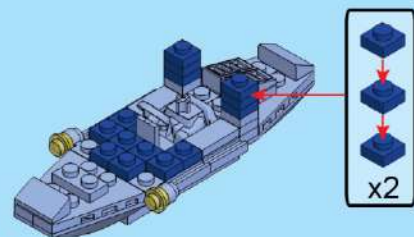

8

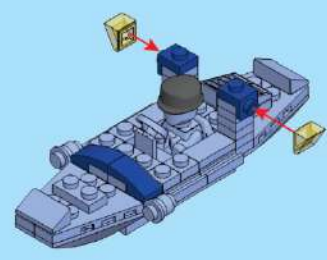

9

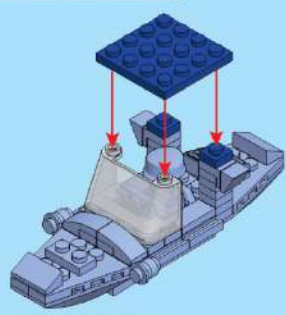

10

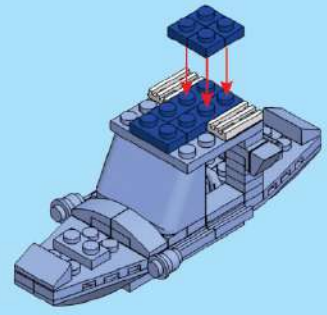

11

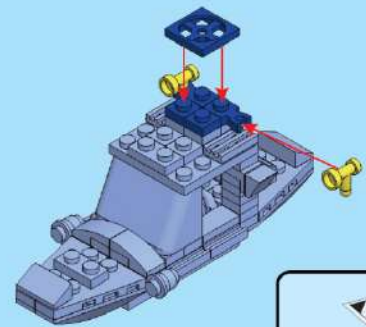

12

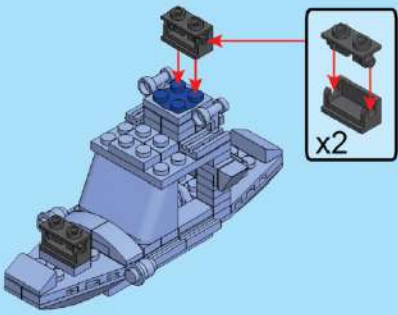

13

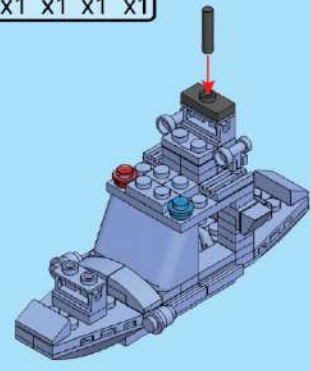

14

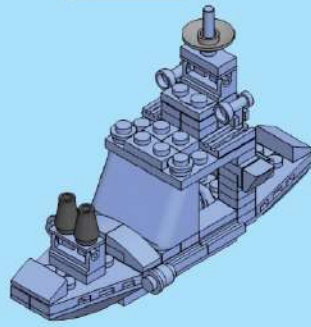

15

