











1

-  X1
-  X1
-  X1
-  X1
-  X1
-  X1
-  X1
-  X1
-  X1
-  X1
-  X2
-  X5



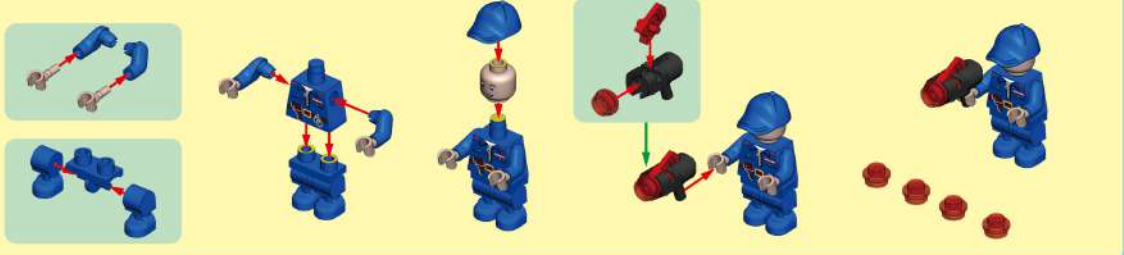

2

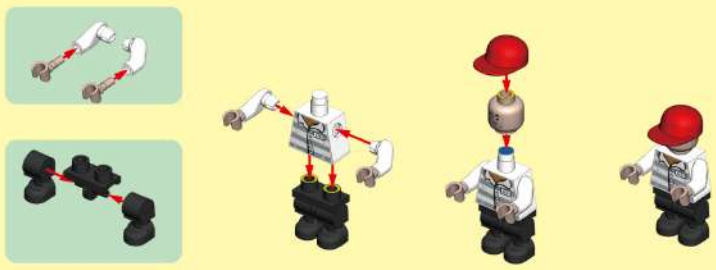
-  X1
-  X1
-  X1
-  X1
-  X1
-  X1
-  X1
-  X1
-  X2





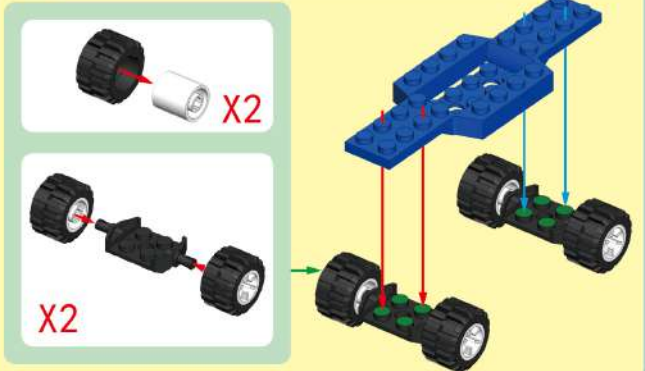

3

-  X1
-  X2
-  X4
-  X4



4

-  X1
-  X1
-  X1
-  X1
-  X1

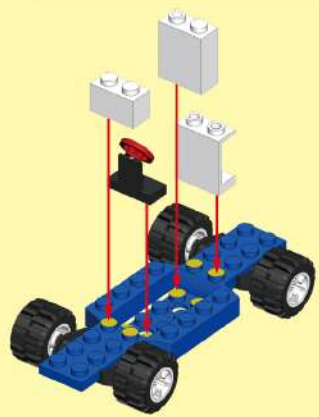





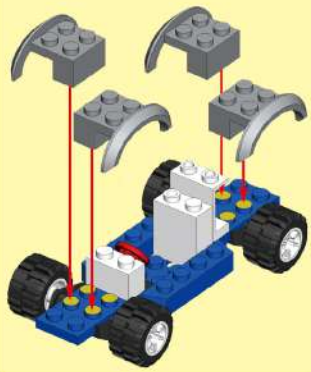



5

-  X4



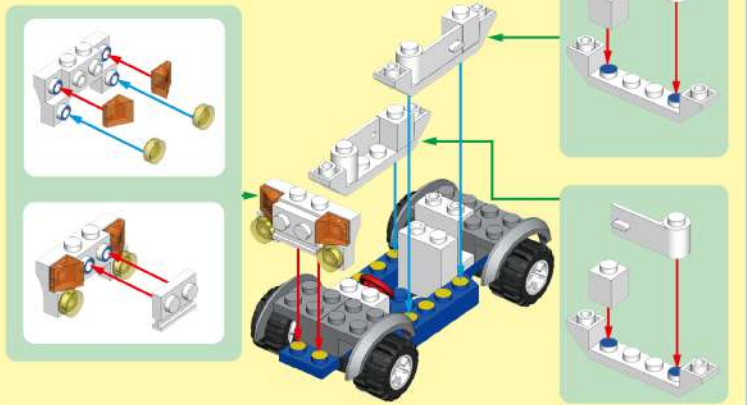

6

-  X1
-  X2
-  X1
-  X1
-  X1
-  X2
-  X2
-  X2



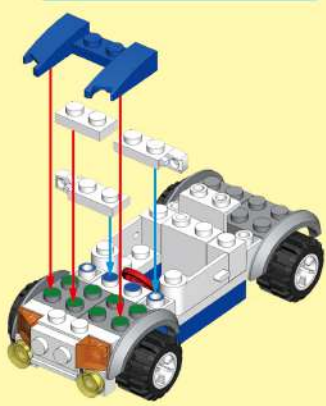

7

-  X1
-  X2
-  X1



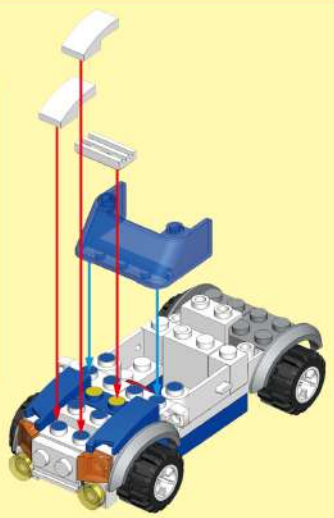

8

-  X1
-  X2
-  X1



9

-  X1
-  X2

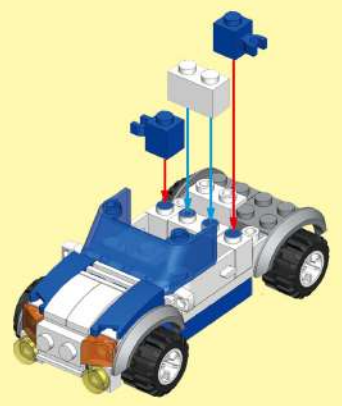

10

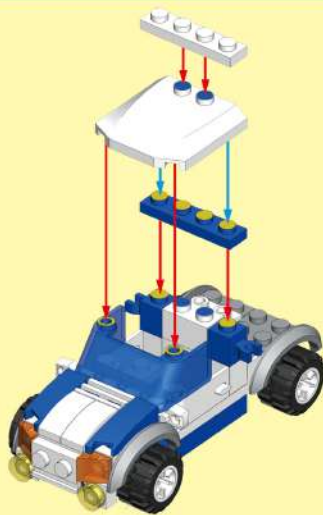
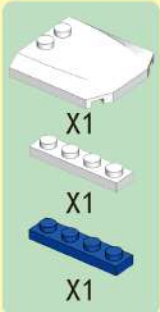

11

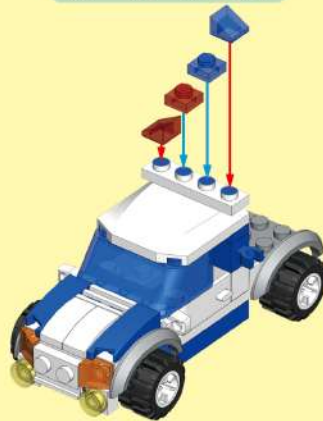

12

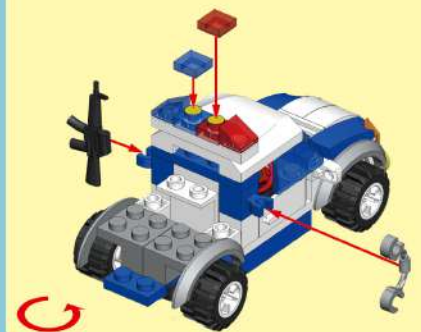

13

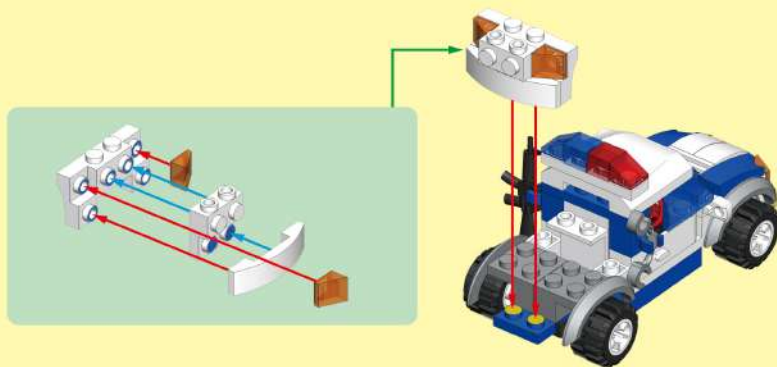

14

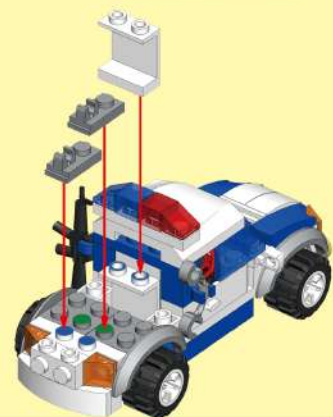
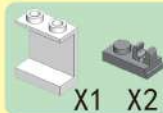

15

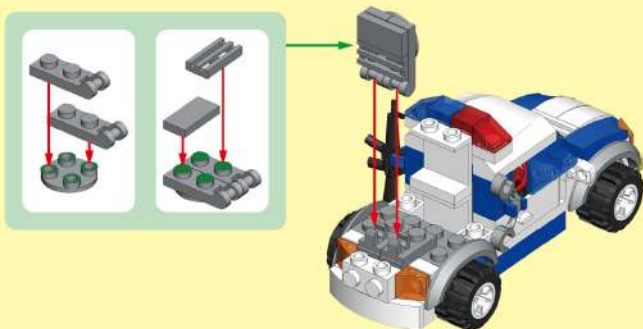
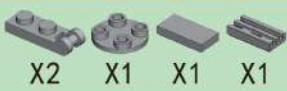

16

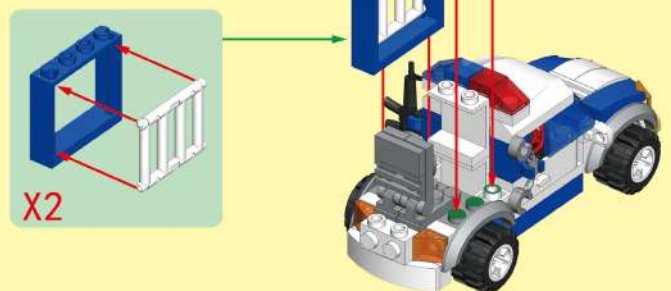
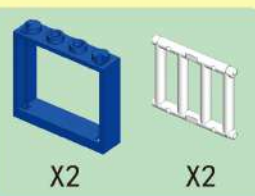

17

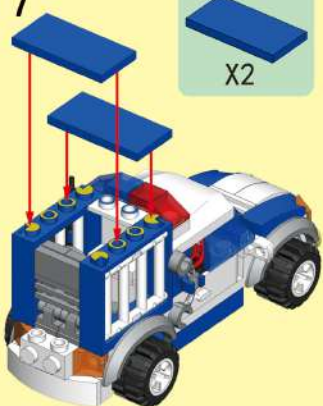
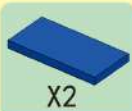

18

1+2+17

