

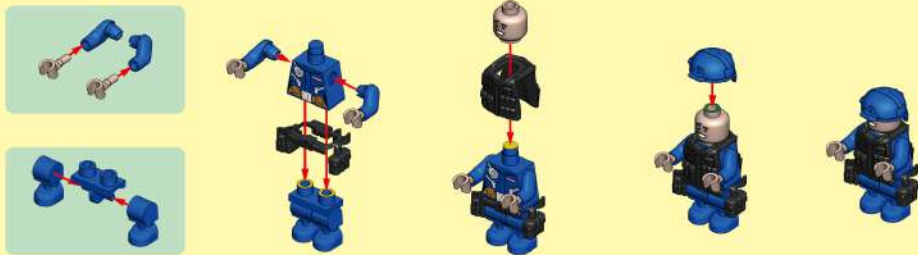

1

-  X1
-  X1
-  X1
-  X1
-  X1
-  X1
-  X1
-  X1
-  X1
-  X1
-  X2





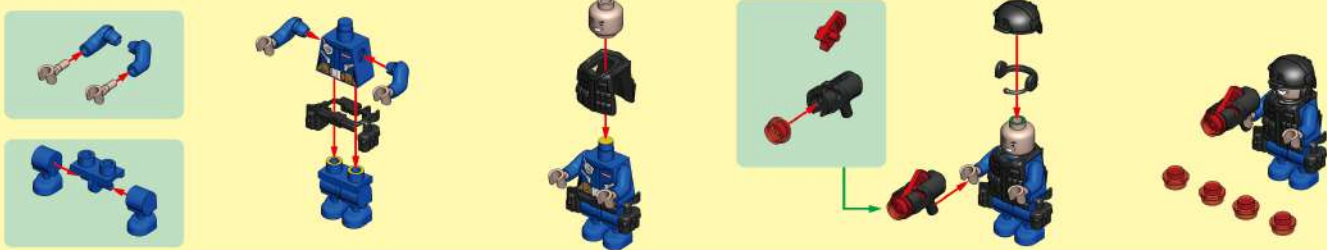

2

-  X1
-  X1
-  X1
-  X1
-  X1
-  X1
-  X1
-  X1
-  X1
-  X1
-  X1
-  X1
-  X1
-  X2
-  X5

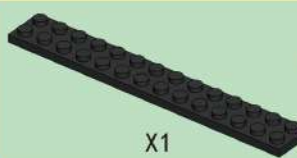



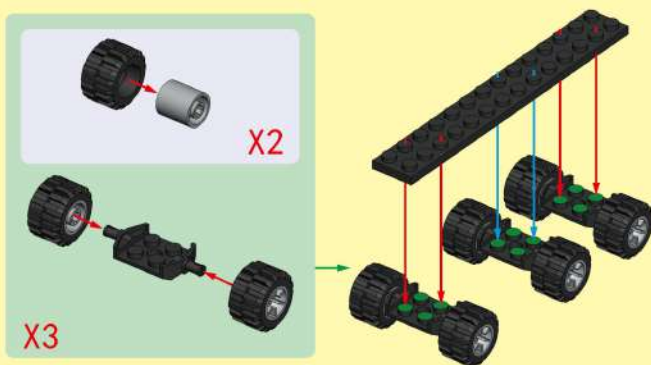

3

-  X1
-  X3
-  X6
-  X6



4

-  X1
-  X1
-  X1
-  X3
-  X2

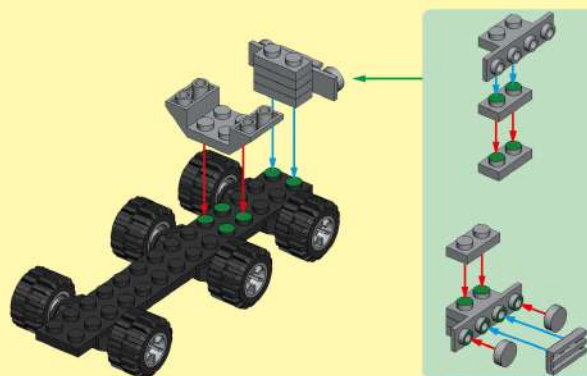

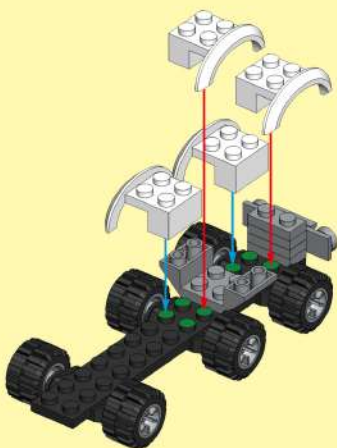

5

-  X4

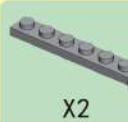
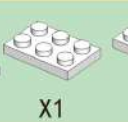
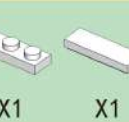
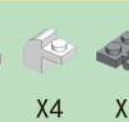
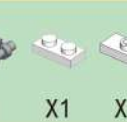

6

-  X2
-  X1
-  X1
-  X1
-  X4
-  X2
-  X1
-  X2

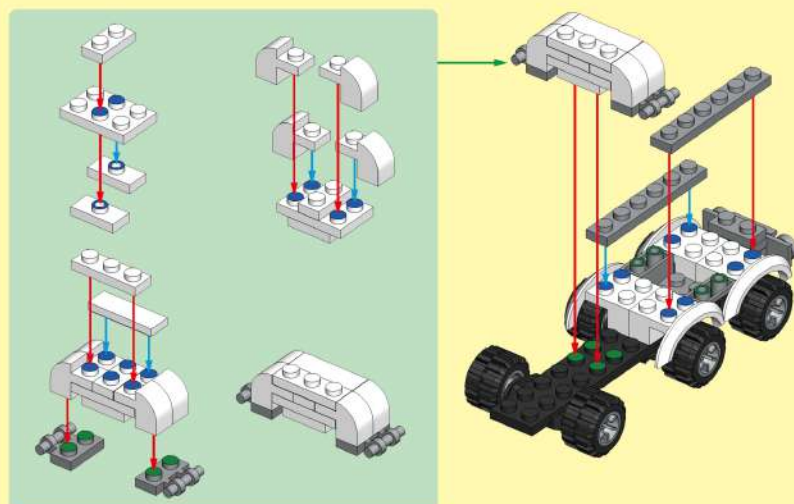

7

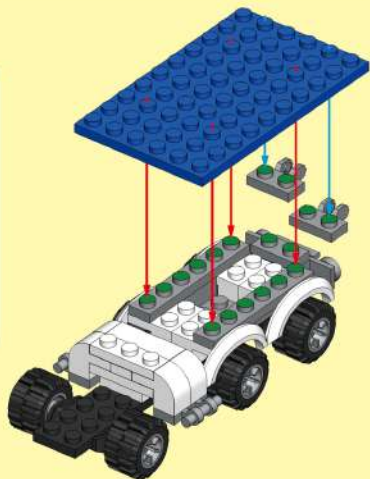
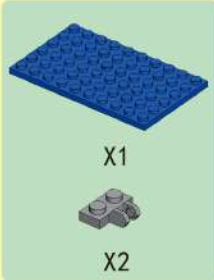

8

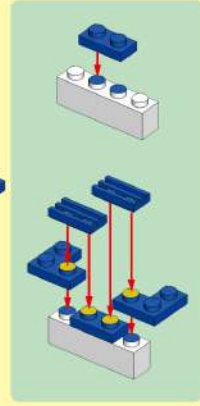
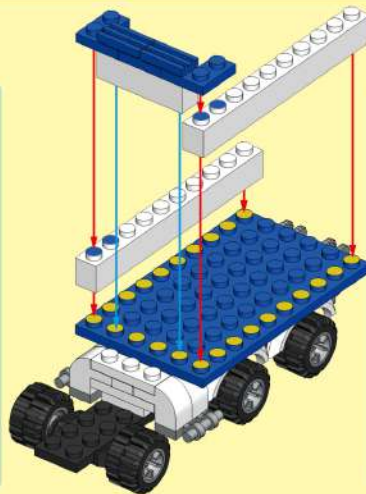
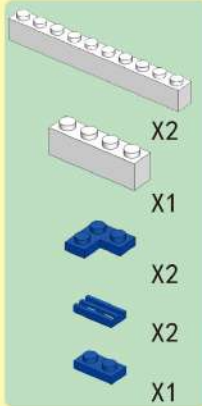

9

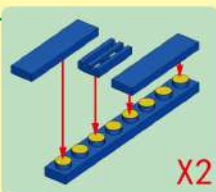
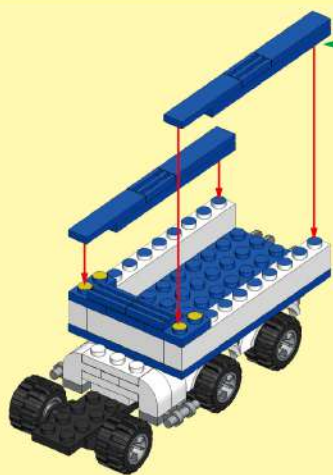
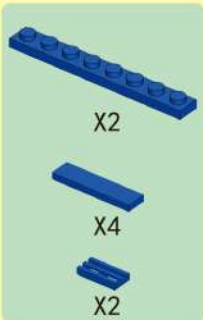

10

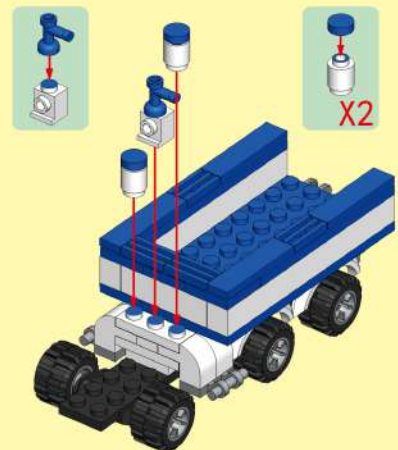

11

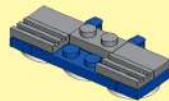
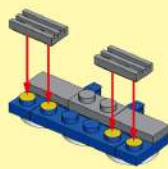
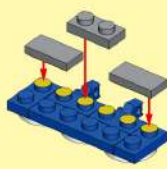
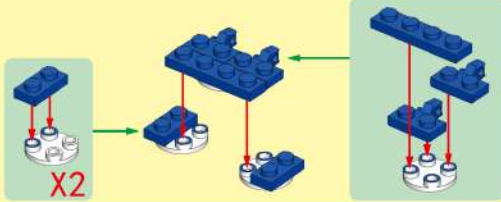

C

12

10+11

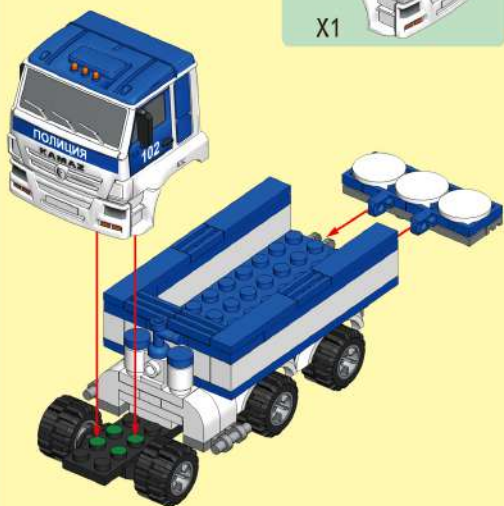

13

1+2+12

