

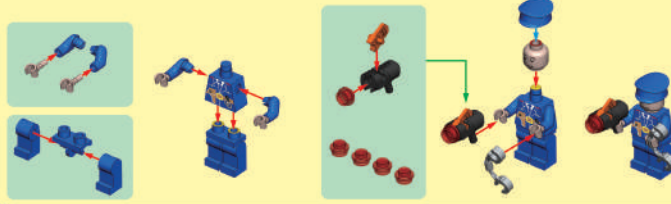

- 1
- X1
  - X1
  - X1
  - X1
  - X1
  - X1
  - X1
  - X1
  - X1
  - X1
  - X1
  - X5
  - X2

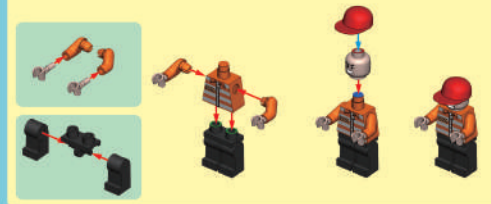

- 2
- X1
  - X1
  - X1
  - X1
  - X1
  - X1
  - X1
  - X1
  - X2



- 3
- X1
  - X3

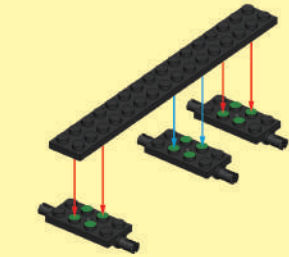

- 4
- X1
  - X1
  - X1
  - X2
  - X1
  - X2

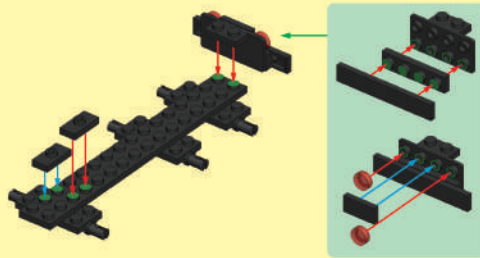

- 5
- X1
  - X1
  - X2
  - X1

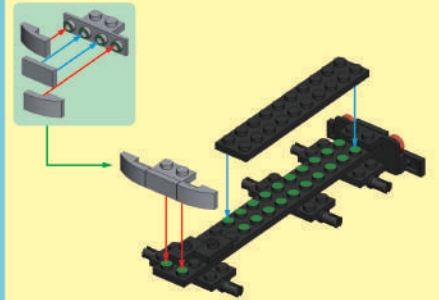

- 6
- X3

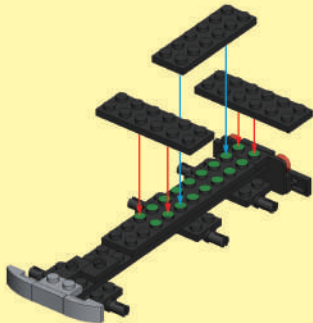

- 7
- X1

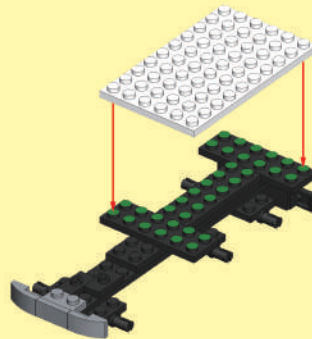

- 8
- X1
  - X8

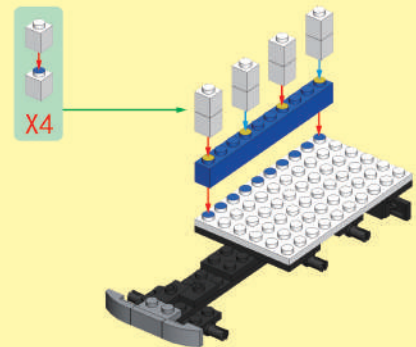

- 9
- X1
  - X1
  - X3
  - X1

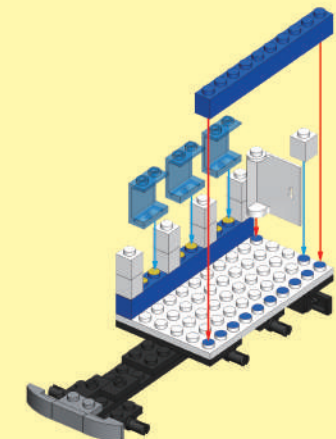

- 10
- X1
  - X2
  - X6

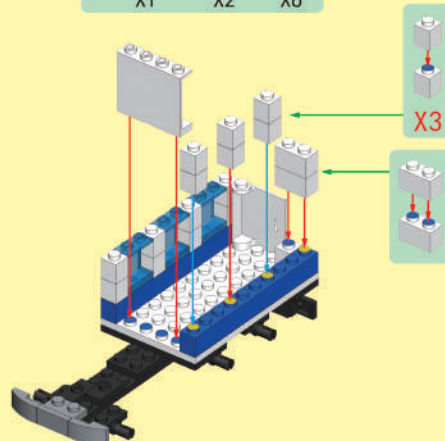

- 11
- X3

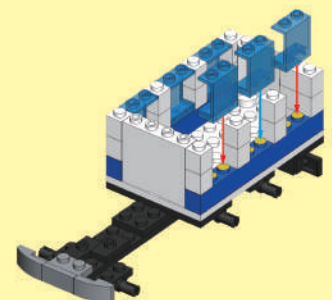

12

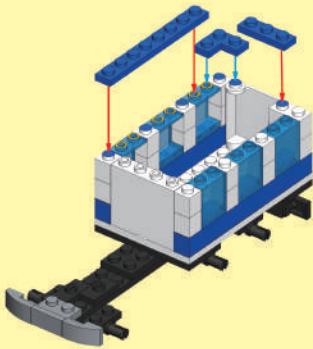
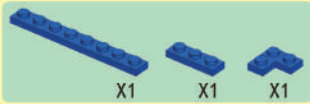

13

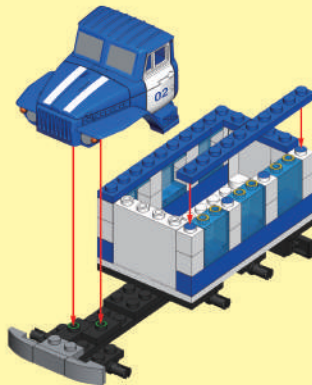
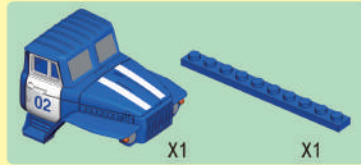

14

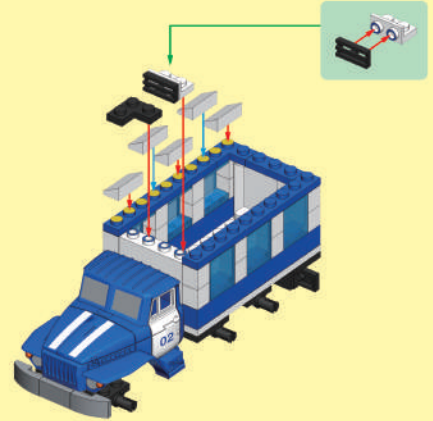

15

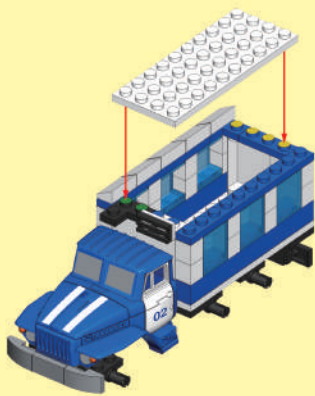
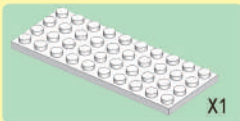

16

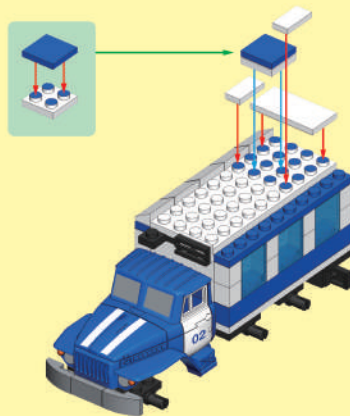

17

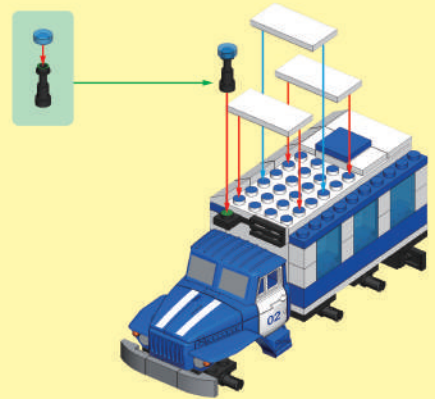

18

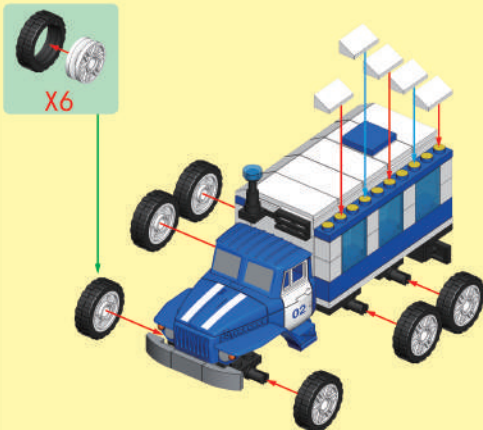

19

1 + 2 + 18

